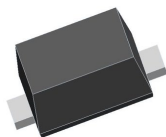

SOD-523
SOD-523 贴片塑封肖特基二极管

SOD-523 Plastic-Encapsulate Schottky Barrier Diode
特征 Features

- 大电流承受能力。High Current Capability
- 正向压降低。Low Forward Voltage Drop

机械数据 Mechanical Data

- 封装: SOD-523 封装 SOD-523 Small Outline Plastic Package
- 极性: 色环端为负极 Polarity: Color band denotes cathode end
- 安装位置: 任意 Mounting Position: Any

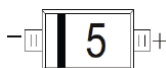
MARKING: 5

极限值和温度特性(TA = 25°C 除非另有规定)

Maximum Ratings & Thermal Characteristics (Ratings at 25°C ambient temperature unless otherwise specified.)

参数 Parameters	符号 Symbol	Limit	单位 Unit
峰值反向电压 Peak reverse voltage	VRM	40	V
直流反向电压 DC reverse voltage	VR	30	V
整流电流 Mean rectifying current	Io	30	mA
峰值正向浪涌电流 Peak forward surge current 8.3 ms single half sine-wave	IFSM	0.2	A
典型热阻 Typical thermal resistance	RθJA	667	°C/W
功率消耗 Power Dissipation	PD	125	mW
存储温度 Storage temperature range	TSTG	-50-+150	°C

电特性 (TA = 25°C 除非另有规定)

Electrical Characteristics (Ratings at 25°C ambient temperature unless otherwise specified).

参数 Parameters	符号 Symbol	测试条件 Test conditions	Min	Typ	Max	单位 Unit
最大正向电压 Maximum forward voltage	VF	IF = 1mA			0.37	V
最大反向电压 Maximum reverse breakdown voltage	VR	IR=1mA	40			V
最大反向电流 Maximum reverse current	IR	VR=30V			0.5	uA
极间电容 Capacitance between terminals	CT	VR=1V, f=1MHz		2		pF

Typical Performance Characteristics (TA=25°C unless otherwise Specified)

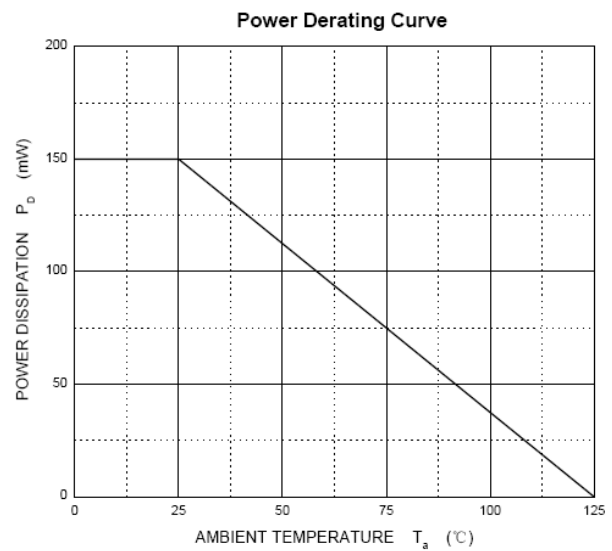
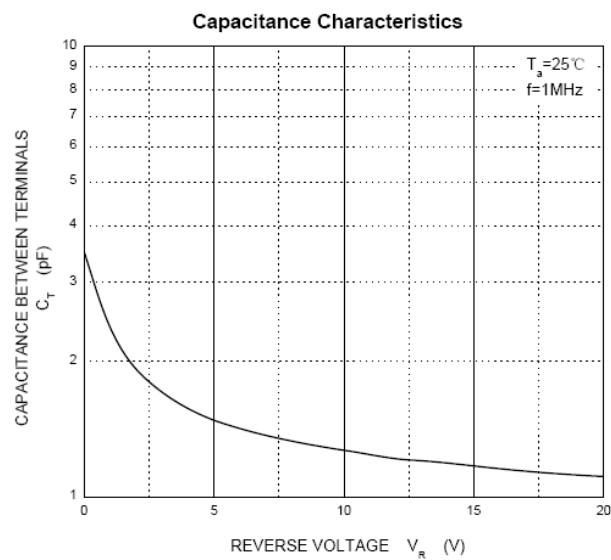
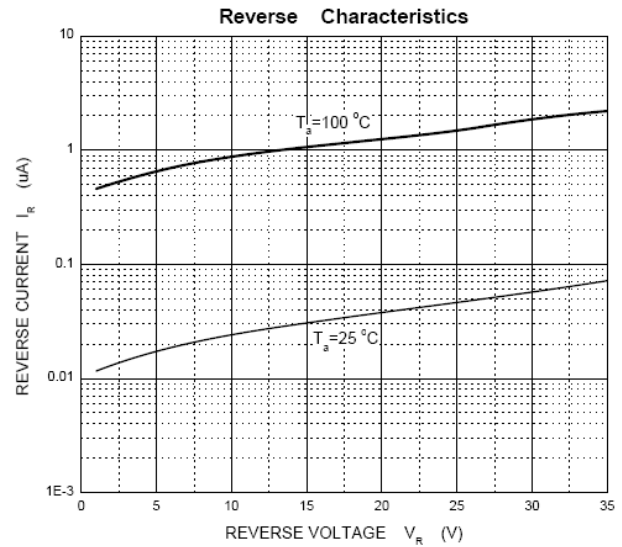
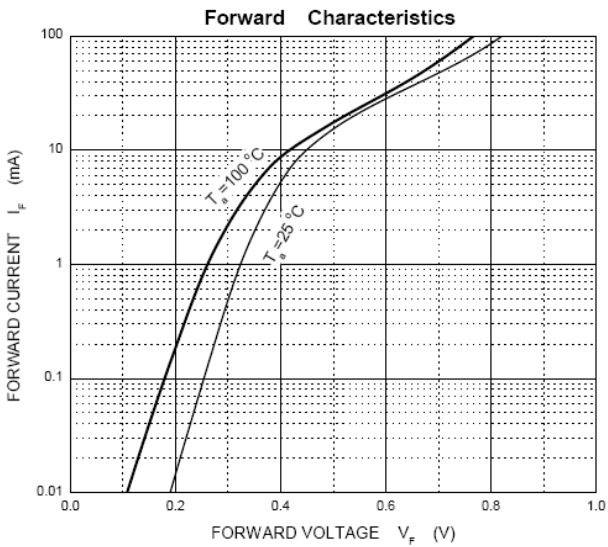

SOD-523 Package Outline Drawing

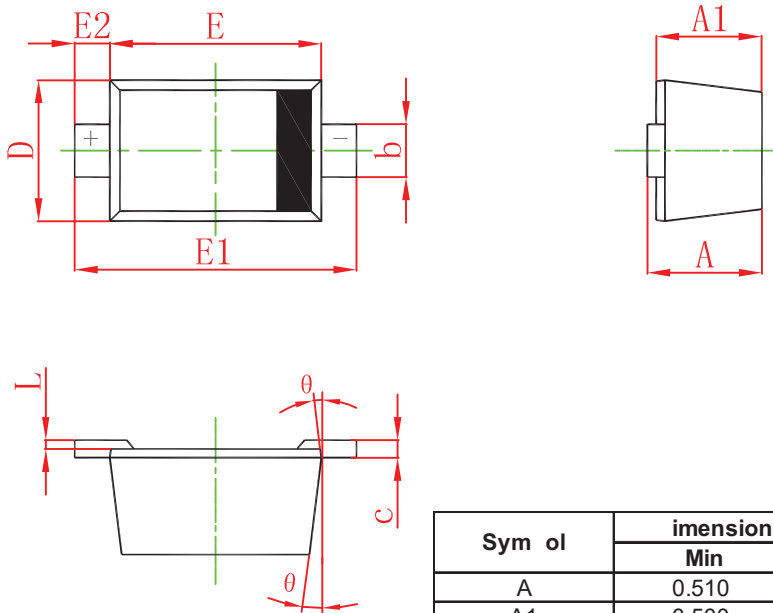

Sym ol	Dimensions In Millimeters		Dimensions In Inches	
	Min	Max	Min	Max
A	0.510	0.770	0.020	0.031
A1	0.500	0.700	0.020	0.028
b	0.250	0.350	0.010	0.014
c	0.080	0.150	0.003	0.006
D	0.750	0.850	0.030	0.033
E	1.100	1.300	0.043	0.051
E1	1.500	1.700	0.059	0.067
E2	0.200 REF		0.008 REF	
L	0.010	0.070	0.001	0.003
θ	7° REF		7° REF	

Suggested Land Pattern

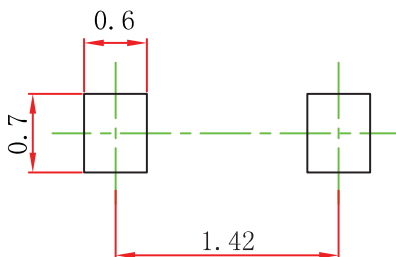

- Note:
1. Controlling dimension: in millimeters.
 2. General tolerance: $\pm 0.05\text{mm}$.
 3. The pad layout is for reference purposes only.